

RAK Des 101 WALL BASIN

RAK
CERAMICS

Features

- Alpine white finish
- Vitreous china
- No tap hole or 1 tap hole, with overflow
- Requires 32 mm overflow waste (not included)
- Chrome overflow ring available separately: **OVERFLOW**
- Weight: 32 kg
- Made in UAE

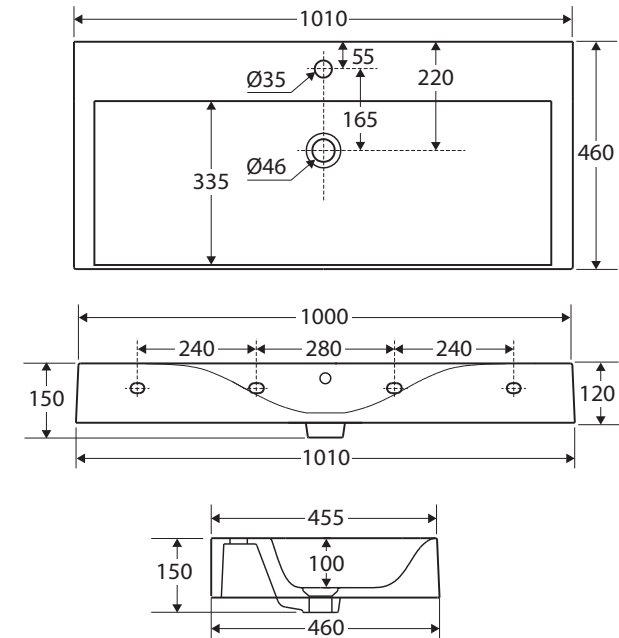

Available in



No Tap Hole
With Overflow
10100AWHA



1 Tap Hole
With Overflow
10101AWHA

Cleaning & Care

- Wipe with a clean, soft cloth and mild soapy water or non-abrasive bathroom cleaner. Test in an inconspicuous area before cleaning the whole basin.
- Avoid placing hot objects, such as hair straighteners, on any surface as these will cause discolouration and marking.
- Spills of hair dye, after-shave lotion, nail polish and remover, aerosol spray and other harsh chemicals should be removed immediately to prevent damage and discolouration. Clean immediately with mild soapy water using a clean, soft cloth.

We aim to ensure that specifications are correct at the time of publication. All measurements are shown in millimetres. For ceramic products, please allow +/- 10 mm tolerance for manufacturing variance. Always use measurements of actual product received for final specification as the technical drawing may contain differences. Due to printing limitations, physical colour may vary from the image shown. Fienza reserves the right to make modifications without prior notice.